

Data sheet | Item number: 769-202

2-pin disconnect carrier terminal block; with 2 jumper positions; for DIN-rail
35 x 15 and 35 x 7.5

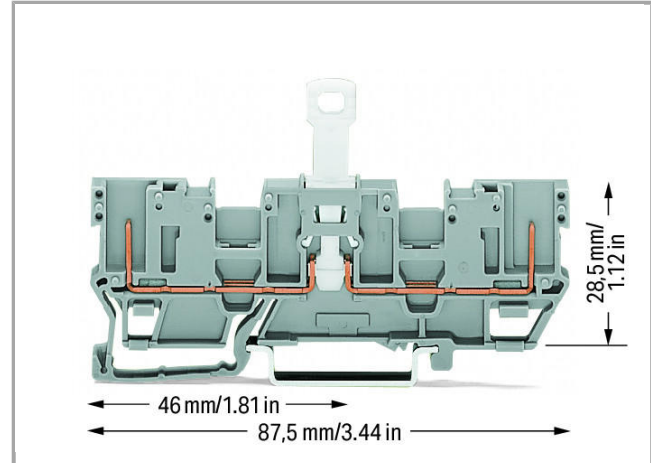

769-202

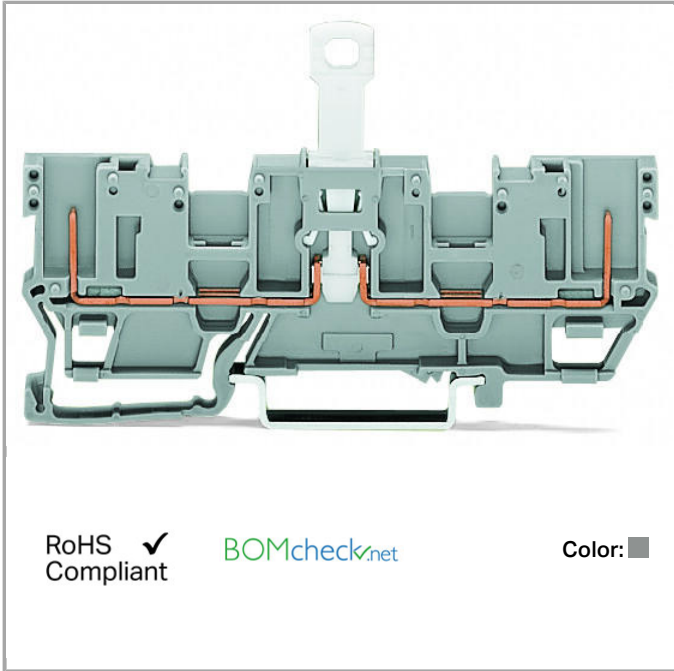

Data

Electrical data

Ratings per IEC/EN 60664-1

Rated voltage (III / 3)	400 V
Rated impulse voltage (III / 3)	6 kV
Rated current	16 A

Connection data

Total number of potentials	1
Number of levels	1
Type of wiring	Front-entry wiring

Geometrical Data

Width	5 mm / 0.197 inch
Height from upper-edge of DIN-35 rail	28.5 mm / 1.122 inch
Depth	87.5 mm / 3.445 inch

Mechanical data

Design	horizontal
Type of mounting	DIN-35 rail
Marking level	Center marking

Material Data



Color	gray
Insulating material	Polyamide 66 (PA 66)
Fire load	0.179 MJ
Weight	8.17 g

Commercial data

Product Group	18 (X-COM-System)
Country of origin	DE
GTIN	4044918630108
Customs Tariff No.	85365080990

Approvals / Certificates

Country specific Approvals

Logo	Approval	Additional Approval Text	Certificate name
	CCA DEKRA Certification B.V.	EN 60947	NTR NL-7626
	CSA DEKRA Certification B.V.	C22.2 No. 158	1101144
	KEMA/KEUR DEKRA Certification B.V.	EN 60947	2190419.01

Ship Approvals



Logo	Approval	Additional Approval Text	Certificate name
	ABS American Bureau of Shipping	EN 60947	14-HG1293677-PDA
	LR	EN 60947	91/20112



Lloyds Register







(E9)

















UL-Approvals

















Logo	Approval	Additional Approval Text	Certificate name
	UR Underwriters Laboratories Inc.	UL 1977	E45171
	UR Underwriters Laboratories Inc.	UL 1059	E45172



















Compatible products















General accessories















	Item no.: 280-404 Test plug adapter; 5 mm wide; for test plug 210-137 (2.3 mm Ø); suitable for 1.5 mm ² - 4 mm ² tbs	280-404
	Item no.: 280-418 Test plug module; modular; suitable for all WAGO 280 and 780 Series rail-mounted terminal blocks with jumper slots in the current bar	280-418
	Item no.: 280-419 Spacer module; modular; bridging commoned terminal blocks	280-419
	Item no.: 709-170 Disconnect lock; for disconnect tab used on 280/281 and 769 Series disconnect terminal blocks	709-170
	Item no.: 769-438 Pin cover; with marker slot for miniature WSB	769-438
	Item no.: 769-439 Pin cover; with marker slot for miniature WSB	769-439
	Item no.: 769-501 Start module for 1-conductor female connector; with integrated end plate; 4 mm ² ; 1-pole	769-501















	Item no.: 769-501/000-006 Start module for 1-conductor female connector; 4 mm ² ; 1-pole	769-501
		/UUU-UUb
	Item no.: 769-501/000-016 Start module for 1-conductor female connector; with integrated end plate; 4 mm ² ; 1-pole	769-501
		/UUU-U 1b
	Item no.: 769-502 Center module for 1-conductor female connector; 4 mm ² ; 1-pole	769-502
	Item no.: 769-502/000-006 Center module for 1-conductor female connector; 4 mm ² ; 1-pole	769-502
		/UUU-UUb
	Item no.: 769-502/000-016 Center module for 1-conductor female connector; 4 mm ² ; 1-pole	769-502
		/UUU-U 1b
	Item no.: 769-503 End module for 1-conductor female connector; 4 mm ² ; 1-pole	769-503
	Item no.: 769-503/000-006 End module for 1-conductor female connector; 4 mm ² ; 1-pole	769-503
		/UUU-UUb
	Item no.: 769-503/000-016 End module for 1-conductor female connector; 4 mm ² ; 1-pole	769-503
		/UUU-U 1b
	Item no.: 769-504 Start module for 2-conductor female connector; with integrated end plate; 4 mm ² ; 1-pole	769-504
	Item no.: 769-504/000-006 Start module for 2-conductor female connector; with integrated end plate; 4 mm ² ; 1-pole	769-504
		/UUU-UUb
	Item no.: 769-504/000-016 Start module for 2-conductor female connector; 4 mm ² ; 1-pole	769-504
		/UUU-U 1b
	Item no.: 769-505 Center module for 2-conductor female connector; 4 mm ² ; 1-pole	769-505
	Item no.: 769-505/000-006 Center module for 2-conductor female connector; 4 mm ² ; 1-pole	769-505
		/UUU-UUb
	Item no.: 769-505/000-016 Center module for 2-conductor female connector; 4 mm ² ; 1-pole	769-505
		/UUU-U 1b
	Item no.: 769-506 End module for 2-conductor female connector; 4 mm ² ; 1-pole	769-506
	Item no.: 769-506/000-006 End module for 2-conductor female connector; 4 mm ² ; 1-pole	769-506
		/UUU-UUb















	Item no.: 769-506/000-016 End module for 2-conductor female connector; 4 mm ² ; 1-pole	/UUU-U 1 0	769-506
	Item no.: 769-512 Start module for 1-conductor female connector; angled; 4 mm ² ; 1-pole		769-512
	Item no.: 769-512/000-006 Start module for 1-conductor female connector; angled; 4 mm ² ; 1-pole	/UUU-U 0 6	769-512
	Item no.: 769-512/000-016 Start module for 1-conductor female connector; angled; 4 mm ² ; 1-pole	/UUU-U 1 6	769-512
	Item no.: 769-513 Center module for 1-conductor female connector; angled; 4 mm ² ; 1-pole		769-513
	Item no.: 769-513/000-006 1-conductor center module; angled; codable; 1-pole	/UUU-U 0 6	769-513
	Item no.: 769-513/000-016 1-conductor center module; angled; codable; 1-pole	/UUU-U 1 6	769-513
	Item no.: 769-515 1-conductor end module; angled; codable; 1-pole		769-515
	Item no.: 769-515/000-006 1-conductor end module; angled; codable; 1-pole	/UUU-U 0 6	769-515
	Item no.: 769-515/000-016 1-conductor end module; angled; codable; 1-pole	/UUU-U 1 6	769-515
Carrier rail			
	Item no.: 210-112 Steel carrier rail; 35 x 7.5 mm; 1 mm thick; 2 m long; slotted; according to EN 60715; "Hole width 25 mm		210-112
	Item no.: 210-113 Steel carrier rail; 35 x 7.5 mm; 1 mm thick; 2 m long; unslotted; according to EN 60715		210-113
	Item no.: 210-114 Steel carrier rail; 35 x 15 mm; 1.5 mm thick; 2 m long; unslotted; similar to EN 60715		210-114
	Item no.: 210-115 Steel carrier rail; 35 x 7.5 mm; 1 mm thick; 2 m long; slotted; according to EN 60715; "Hole width 18 mm		210-115
	Item no.: 210-118 Steel carrier rail; 35 x 15 mm; 2.3 mm thick; 2 m long; unslotted; according to EN 60715		210-118
	Item no.: 210-196 Aluminum carrier rail; 35 x 8.2 mm; 1.6 mm thick; 2 m long; unslotted; similar to EN 60715		210-196
	Item no.: 210-197 Steel carrier rail; 35 x 15 mm; 1.5 mm thick; 2 m long; slotted; similar to EN 60715		210-197















	Item no.: 210-198 Copper carrier rail; 35 x 15 mm; 2.3 mm thick; 2 m long; unslotted; according to EN 60715	210-198
	Item no.: 210-504 Steel carrier rail; 35 x 7.5 mm; 1 mm thick; 2 m long; slotted; galvanized; according to EN 60715	210-504
	Item no.: 210-505 Steel carrier rail; 35 x 7.5 mm; 1 mm thick; 2 m long; unslotted; galvanized; according to EN 60715	210-505
	Item no.: 210-506 Steel carrier rail; 35 x 15 mm; 1.5 mm thick; 2 m long; unslotted; galvanized; similar to EN 60715	210-506
	Item no.: 210-508 Steel carrier rail; 35 x 15 mm; 1.5 mm thick; 2 m long; slotted; galvanized; similar to EN 60715	210-508
Jumper		
	Item no.: 249-123 Push-in type wire jumper; insulated; wire length 180 mm; Conductor cross section 0.75 mm ²	249-123
	Item no.: 249-125 Push-in type wire jumper; insulated; wire length 60 mm; Conductor cross section 0.75 mm ²	249-125
	Item no.: 249-126 Push-in type wire jumper; insulated; wire length 110 mm; Conductor cross section 0.75 mm ²	249-126
	Item no.: 249-127 Push-in type wire jumper; insulated; wire length 250 mm; Conductor cross section 0.75 mm ²	249-127
	Item no.: 280-402 Adjacent jumper; insulated; IN = IN terminal block	280-402
	Item no.: 280-409 Alternate jumper; insulated; IN = IN terminal block	280-409
	Item no.: 780-452 Staggered jumper; insulated; from 1 to 2; Spacing: 5 mm; suitable for 2-conductor female plugs	780-452
	Item no.: 780-453 Staggered jumper; insulated; from 1 to 3; Spacing: 5 mm; suitable for 2-conductor female plugs	780-453
	Item no.: 780-454 Staggered jumper; insulated; from 1 to 4; Spacing: 5 mm; suitable for 2-conductor female plugs	780-454
	Item no.: 780-455 Staggered jumper; insulated; from 1 to 5; Spacing: 5 mm; suitable for 2-conductor female plugs	780-455
	Item no.: 780-456 Staggered jumper; insulated; from 1 to 6; Spacing: 5 mm; suitable for 2-conductor female plugs	780-456
	Item no.: 780-457 Staggered jumper; insulated; from 1 to 7; Spacing: 5 mm; suitable for 2-conductor female plugs	780-457
	Item no.: 780-458 Staggered jumper; insulated; from 1 to 8; Spacing: 5 mm; suitable for 2-conductor female plugs	780-458
Female plug		
	Item no.: 769-101 1-conductor female plug; 4 mm ² ; 1-pole	769-101















	Item no.: 769-101/000-006 1-conductor female plug; 4 mm ² ; 1-pole	769-101 /000-006
	Item no.: 769-101/000-016 1-conductor female plug; 4 mm ² ; 1-pole	769-101 /000-016
	Item no.: 769-101/022-000 1-conductor female plug; angled; 4 mm ² ; 1-pole	769-101 /022-000
	Item no.: 769-101/022-016 1-conductor female plug; angled; 4 mm ² ; 1-pole	769-101 /022-016
	Item no.: 769-102 1-conductor female plug; 4 mm ² ; 2-pole	769-102
	Item no.: 769-102/000-006 1-conductor female plug; 4 mm ² ; 2-pole	769-102 /000-006
	Item no.: 769-102/000-036 1-conductor female plug; 4 mm ² ; 2-pole	769-102 /000-036
	Item no.: 769-102/000-037 1-conductor female plug; 4 mm ² ; 2-pole	769-102 /000-037
	Item no.: 769-102/022-000 1-conductor female plug; angled; 4 mm ² ; 2-pole	769-102 /022-000
	Item no.: 769-103 1-conductor female plug; 4 mm ² ; 3-pole	769-103
	Item no.: 769-103/000-006 1-conductor female plug; 4 mm ² ; 3-pole	769-103 /000-006
	Item no.: 769-103/000-036 1-conductor female plug; 4 mm ² ; 3-pole	769-103 /000-036
	Item no.: 769-103/000-037 1-conductor female plug; 4 mm ² ; 3-pole	769-103 /000-037
	Item no.: 769-103/000-038 1-conductor female plug; 4 mm ² ; 3-pole	769-103 /000-038
	Item no.: 769-103/000-039 1-conductor female plug; 4 mm ² ; 3-pole	769-103 /000-039

















	Item no.: 769-103/022-000 1-conductor female plug; angled; 4 mm²; 3-pole	769-103 /022-000
	Item no.: 769-104 1-conductor female plug; 4 mm²; 4-pole	769-104
	Item no.: 769-104/000-006 1-conductor female plug; 4 mm²; 4-pole	769-104 /000-006
	Item no.: 769-104/000-036 1-conductor female plug; 4 mm²; 4-pole	769-104 /000-036
	Item no.: 769-104/000-037 1-conductor female plug; 4 mm²; 4-pole	769-104 /000-037
	Item no.: 769-104/000-038 1-conductor female plug; 4 mm²; 4-pole	769-104 /000-038
	Item no.: 769-104/000-039 1-conductor female plug; 4 mm²; 4-pole	769-104 /000-039
	Item no.: 769-104/022-000 1-conductor female plug; angled; 4 mm²; 4-pole	769-104 /022-000
	Item no.: 769-105 1-conductor female plug; 4 mm²; 5-pole	769-105
	Item no.: 769-105/000-006 1-conductor female plug; 4 mm²; 5-pole	769-105 /000-006
	Item no.: 769-105/000-036 1-conductor female plug; 4 mm²; 5-pole	769-105 /000-036
	Item no.: 769-105/000-037 1-conductor female plug; 4 mm²; 5-pole	769-105 /000-037
	Item no.: 769-105/000-038 1-conductor female plug; 4 mm²; 5-pole	769-105 /000-038
	Item no.: 769-105/000-039 1-conductor female plug; 4 mm²; 5-pole	769-105 /000-039
	Item no.: 769-105/022-000 1-conductor female plug; angled; 4 mm²; 5-pole	769-105 /022-000
	Item no.: 769-106	

















	1-conductor female plug; 4 mm ² ; 6-pole		769-106
	Item no.: 769-106/000-006 1-conductor female plug; 4 mm ² ; 6-pole	/000-006	769-106
	Item no.: 769-106/000-036 1-conductor female plug; 4 mm ² ; 6-pole	/000-036	769-106
	Item no.: 769-106/000-037 1-conductor female plug; 4 mm ² ; 6-pole	/000-037	769-106
	Item no.: 769-106/000-038 1-conductor female plug; 4 mm ² ; 6-pole	/000-038	769-106
	Item no.: 769-106/000-039 1-conductor female plug; 4 mm ² ; 6-pole	/000-039	769-106
	Item no.: 769-106/022-000 1-conductor female plug; angled; 4 mm ² ; 6-pole	/022-000	769-106
	Item no.: 769-107 1-conductor female plug; 4 mm ² ; 7-pole		769-107
	Item no.: 769-107/000-006 1-conductor female plug; 4 mm ² ; 7-pole	/000-006	769-107
	Item no.: 769-107/000-036 1-conductor female plug; 4 mm ² ; 7-pole	/000-036	769-107
	Item no.: 769-107/000-037 1-conductor female plug; 4 mm ² ; 7-pole	/000-037	769-107
	Item no.: 769-107/000-038 1-conductor female plug; 4 mm ² ; 7-pole	/000-038	769-107
	Item no.: 769-107/000-039 1-conductor female plug; 4 mm ² ; 7-pole	/000-039	769-107
	Item no.: 769-107/022-000 1-conductor female plug; angled; 4 mm ² ; 7-pole	/022-000	769-107
	Item no.: 769-108 1-conductor female plug; 4 mm ² ; 8-pole		769-108















	Item no.: 769-108/000-006 1-conductor female plug; 4 mm ² ; 8-pole		769-108
		/000-006	
	Item no.: 769-108/000-036 1-conductor female plug; 4 mm ² ; 8-pole		769-108
		/000-036	
	Item no.: 769-108/000-037 1-conductor female plug; 4 mm ² ; 8-pole		769-108
		/000-037	
	Item no.: 769-108/000-038 1-conductor female plug; 4 mm ² ; 8-pole		769-108
		/000-038	
	Item no.: 769-108/000-039 1-conductor female plug; 4 mm ² ; 8-pole		769-108
		/000-039	
	Item no.: 769-108/022-000 1-conductor female plug; angled; 4 mm ² ; 8-pole		769-108
		/022-000	
	Item no.: 769-109 1-conductor female plug; 4 mm ² ; 9-pole		769-109
	Item no.: 769-109/000-006 1-conductor female plug; 4 mm ² ; 9-pole		769-109
		/000-006	
	Item no.: 769-109/000-036 1-conductor female plug; 4 mm ² ; 9-pole		769-109
		/000-036	
	Item no.: 769-109/000-037 1-conductor female plug; 4 mm ² ; 9-pole		769-109
		/000-037	
	Item no.: 769-109/000-038 1-conductor female plug; 4 mm ² ; 9-pole		769-109
		/000-038	
	Item no.: 769-109/000-039 1-conductor female plug; 4 mm ² ; 9-pole		769-109
		/000-039	
	Item no.: 769-109/022-000 1-conductor female plug; angled; 4 mm ² ; 9-pole		769-109
		/022-000	
	Item no.: 769-110 1-conductor female plug; 4 mm ² ; 10-pole		769-110
	Item no.: 769-110/000-006 1-conductor female plug; 4 mm ² ; 10-pole		769-110
		/000-006	

	Item no.: 769-110/000-036 1-conductor female plug; 4 mm ² ; 10-pole	769-110 /000-036
	Item no.: 769-110/000-037 1-conductor female plug; 4 mm ² ; 10-pole	769-110 /000-037
	Item no.: 769-110/000-038 1-conductor female plug; 4 mm ² ; 10-pole	769-110 /000-038
	Item no.: 769-110/000-039 1-conductor female plug; 4 mm ² ; 10-pole	769-110 /000-039
	Item no.: 769-110/022-000 1-conductor female plug; angled; 4 mm ² ; 10-pole	769-110 /022-000
	Item no.: 769-111 1-conductor female plug; 4 mm ² ; 11-pole	769-111
	Item no.: 769-111/000-006 1-conductor female plug; 4 mm ² ; 11-pole	769-111 /000-006
	Item no.: 769-111/000-036 1-conductor female plug; 4 mm ² ; 11-pole	769-111 /000-036
	Item no.: 769-111/000-037 1-conductor female plug; 4 mm ² ; 11-pole	769-111 /000-037
	Item no.: 769-111/000-038 1-conductor female plug; 4 mm ² ; 11-pole	769-111 /000-038
	Item no.: 769-111/000-039 1-conductor female plug; 4 mm ² ; 11-pole	769-111 /000-039
	Item no.: 769-111/022-000 1-conductor female plug; angled; 4 mm ² ; 11-pole	769-111 /022-000
	Item no.: 769-112 1-conductor female plug; 4 mm ² ; 12-pole	769-112
	Item no.: 769-112/000-006 1-conductor female plug; 4 mm ² ; 12-pole	769-112 /000-006
	Item no.: 769-112/000-036 1-conductor female plug; 4 mm ² ; 12-pole	769-112 /000-036

	Item no.: 769-112/000-037 1-conductor female plug; 4 mm ² ; 12-pole		769-112
		/000-037	
	Item no.: 769-112/000-038 1-conductor female plug; 4 mm ² ; 12-pole		769-112
		/000-038	
	Item no.: 769-112/000-039 1-conductor female plug; 4 mm ² ; 12-pole		769-112
		/000-039	
	Item no.: 769-112/022-000 1-conductor female plug; angled; 4 mm ² ; 12-pole		769-112
		/022-000	
	Item no.: 769-113 1-conductor female plug; 4 mm ² ; 13-pole		769-113
	Item no.: 769-113/000-036 1-conductor female plug; 4 mm ² ; 13-pole		769-113
		/000-036	
	Item no.: 769-113/000-037 1-conductor female plug; 4 mm ² ; 13-pole		769-113
		/000-037	
	Item no.: 769-113/000-038 1-conductor female plug; 4 mm ² ; 13-pole		769-113
		/000-038	
	Item no.: 769-113/000-039 1-conductor female plug; 4 mm ² ; 13-pole		769-113
		/000-039	
	Item no.: 769-113/022-000 1-conductor female plug; angled; 4 mm ² ; 13-pole		769-113
		/022-000	
	Item no.: 769-114 1-conductor female plug; 4 mm ² ; 14-pole		769-114
	Item no.: 769-114/000-006 1-conductor female plug; 4 mm ² ; 14-pole		769-114
		/000-006	
	Item no.: 769-114/000-036 1-conductor female plug; 4 mm ² ; 14-pole		769-114
		/000-036	
	Item no.: 769-114/000-037 1-conductor female plug; 4 mm ² ; 14-pole		769-114
		/000-037	
	Item no.: 769-114/000-038 1-conductor female plug; 4 mm ² ; 14-pole		769-114
		/000-038	

	Item no.: 769-114/000-039 1-conductor female plug; 4 mm²; 14-pole	769-114 /000-039
	Item no.: 769-114/022-000 1-conductor female plug; angled; 4 mm²; 14-pole	769-114 /022-000
	Item no.: 769-115 1-conductor female plug; 4 mm²; 15-pole	769-115
	Item no.: 769-115/000-036 1-conductor female plug; 4 mm²; 15-pole	769-115 /000-036
	Item no.: 769-115/000-037 1-conductor female plug; 4 mm²; 15-pole	769-115 /000-037
	Item no.: 769-115/000-038 1-conductor female plug; 4 mm²; 15-pole	769-115 /000-038
	Item no.: 769-115/000-039 1-conductor female plug; 4 mm²; 15-pole	769-115 /000-039
	Item no.: 769-115/022-000 1-conductor female plug; angled; 4 mm²; 15-pole	769-115 /022-000
	Item no.: 769-121 2-conductor female connector; 4 mm²; 1-pole	769-121
	Item no.: 769-121/000-016 2-conductor female connector; 4 mm²; 1-pole	769-121 /000-016
	Item no.: 769-122 2-conductor female connector; 4 mm²; 2-pole	769-122
	Item no.: 769-123 2-conductor female connector; 4 mm²; 3-pole	769-123
	Item no.: 769-124 2-conductor female connector; 4 mm²; 4-pole	769-124
	Item no.: 769-125 2-conductor female connector; 4 mm²; 5-pole	769-125
	Item no.: 769-126 2-conductor female connector; 4 mm²; 6-pole	769-126
	Item no.: 769-127 2-conductor female connector; 4 mm²; 7-pole	769-127
	Item no.: 769-128 2-conductor female connector; 4 mm²; 8-pole	769-128

	Item no.: 769-129 2-conductor female connector; 4 mm²; 9-pole	769-129
	Item no.: 769-130 2-conductor female connector; 4 mm²; 10-pole	769-130
	Item no.: 769-131 2-conductor female connector; 4 mm²; 11-pole	769-131
	Item no.: 769-132 2-conductor female connector; 4 mm²; 12-pole	769-132
	Item no.: 769-133 2-conductor female connector; 4 mm²; 13-pole	769-133
	Item no.: 769-134 2-conductor female connector; 4 mm²; 14-pole	769-134
	Item no.: 769-135 2-conductor female connector; 4 mm²; 15-pole	769-135
assembling		
	Item no.: 209-106 Mounting carrier; for isolated mounting on DIN 35 rails	209-106
tools		
	Item no.: 210-720 Operating tool with partially insulated shaft; Type 2, blade (3.5 x 0.5) mm	210-720
End plate		
	Item no.: 769-309 End and intermediate plate; 1.1 mm thick	769-309
	Item no.: 769-310 End and intermediate plate; 1.1 mm thick	769-310
	Item no.: 769-313 Separator plate; 1.1 mm thick; oversized	769-313
check		
	Item no.: 210-137 Test plug; 2.3 mm Ø; with 500 mm cable	210-137
Coding		
	Item no.: 769-435 Coding pin; for coding of female plugs; for carrier terminal blocks / male connectors	769-435
Marking accessories		
	Item no.: 2009-145 Mini-WSB Inline; for Smart Printer; on reel; stretchable 5 - 5.2 mm; plain; snap-on type	2009-145
	Item no.: 2009-145/000-002 Mini-WSB Inline; for Smart Printer; on reel; stretchable 5 - 5.2 mm; plain; snap-on type	2009-145 /UUU-UUZ
	Item no.: 2009-145/000-005 Mini-WSB Inline; for Smart Printer; on reel; stretchable 5 - 5.2 mm; plain; snap-on type	2009-145 /UUU-UU5

	Item no.: 2009-145/000-006 Mini-WSB Inline; for Smart Printer; on reel; stretchable 5 - 5.2 mm; plain; snap-on type	/000-006	2009-145
	Item no.: 2009-145/000-007 Mini-WSB Inline; for Smart Printer; on reel; stretchable 5 - 5.2 mm; plain; snap-on type	/000-007	2009-145
	Item no.: 2009-145/000-012 Mini-WSB Inline; for Smart Printer; on reel; stretchable 5 - 5.2 mm; plain; snap-on type	/000-012	2009-145
	Item no.: 2009-145/000-023 Mini-WSB Inline; for smartPRINTER; on reel; stretchable 5 - 5.2 mm; plain; snap-on type	/000-023	2009-145
	Item no.: 2009-145/000-024 Mini-WSB Inline; for Smart Printer; on reel; stretchable 5 - 5.2 mm; plain; snap-on type	/000-024	2009-145
	Item no.: 248-501 Miniature WSB Quick marking system; plain; Marker width 5 mm; 10 strips with 10 markers per card		248-501
	Item no.: 248-501/000-002 Mini-WSB marking card; as card; not stretchable; plain; snap-on type	/000-002	248-501
	Item no.: 248-501/000-005 Mini-WSB marking card; as card; not stretchable; plain; snap-on type	/000-005	248-501
	Item no.: 248-501/000-006 Mini-WSB marking card; as card; not stretchable; plain; snap-on type	/000-006	248-501
	Item no.: 248-501/000-007 Mini-WSB marking card; as card; not stretchable; plain; snap-on type	/000-007	248-501
	Item no.: 248-501/000-012 Mini-WSB marking card; as card; not stretchable; plain; snap-on type	/000-012	248-501
	Item no.: 248-501/000-017 Mini-WSB marking card; as card; not stretchable; plain; snap-on type	/000-017	248-501
	Item no.: 248-501/000-023 Mini-WSB marking card; as card; not stretchable; plain; snap-on type	/000-023	248-501
	Item no.: 248-501/000-024 Mini-WSB marking card; as card; not stretchable; plain; snap-on type	/000-024	248-501



Downloads

Documentation

Bid Text

769-202	doc 25.1 kB	Download
---------	----------------	----------

CAD/CAE - Smart Data

CAD data

3D Download 769-202	URL	Download
---------------------	-----	----------

Product family

X-COM

[Learn more about the product family.](#)

[Show all products from the family](#)

Subject to changes.
